

NESPRESSO
PROFESSIONAL



Momento 100

User Manual

(Original instructions)



Nespresso Momento 100

Nespresso Professional coffee machine

Table of Contents

Safety precautions and general information	6
Machine overview	10
Machine set-up	12
Prepare your beverage.....	16
Settings.....	18
Daily cleaning and maintenance	24
Troubleshooting.....	30
Appendix.....	34



Welcome to
Nespresso Professional

To help your company make the most of your **Nespresso** machine,
let us guide you through everything this machine has to offer.
It has many features that you will discover and enjoy. Nothing is more
important than ensuring you enjoy the same high quality cup after cup,
which is why we guarantee the performance of your machine as a
natural part of our after-sales service.

How will you create your ideal coffee experience?

**SAFETY PRECAUTIONS AND
GENERAL INFORMATION**

SAFETY PRECAUTIONS

Please read all instructions in this user manual before operating the machine.

General safety notes

- In the event of emergency, switch off the machine with the main switch located under the water tank, behind the drip tray. Unplug the machine. If your machine is plumbed in, turn off the water mains supply to the machine.
- This appliance can be used by children aged from 8 years and above and persons with reduced physical, sensory or mental capabilities or lack of experience and knowledge if they have been given supervision or instruction concerning the use of the appliance in a safe way and they understand the hazards involved. Children must not play with the appliance.
- At least one copy of this user manual should be kept in a location available at all times to maintenance and management staff. Safety instructions must be available for all users.

NOTE: This appliance contains a class-1 laser product.

WARNING:

Risk of electric shock

Contact with electrical components during operation of the machine could result in death or serious injury.

- The machine must only be installed, relocated, removed, repaired or maintained by authorised, trained service staff.
- Ensure that your machine voltage is the same as your mains voltage.
- Do not open the casing under any circumstances.
- Keep the machine away from moisture.
- Never immerse the machine, cable or plug in water or any other liquid.
- Protect the cable from sharp edges.
- Machine cables must be positioned out of the reach of children.
- Immediately stop using the machine if cable or plug are damaged.
- Do not position the cable near or on hot parts of the machine. Using the machine near open flames is strictly prohibited.

Risk of food safety

Ingestion of contaminated food could result in death or serious injury.

- Clean the machine periodically and in accordance with this user manual.
- During cleaning or descaling process, please make sure to identify that the machine cannot be used, in order to avoid consumer ingestion of cleaning/descaling agent.
- Only fill water tank with drinkable water.

CAUTION:

Risk of scalding

Contact with hot fluids could result in minor or moderate injury.

- Do not perform work underneath the product outlet.
- Avoid direct contact with hot fluids.
- Do not touch any part of the outlet before or after a beverage has been dispensed.
- Empty the drip tray with caution.

Risk of bruising

Handling inside the machine could result in minor or moderate injury.

- Do not put fingers into the capsule insertion slot.
- If a capsule is blocked in the capsule insertion slot, switch off and unplug the machine before performing any operation.

- At least one copy of this user manual should be kept in a location available at all times to maintenance and management staff. Safety instructions must be available for all users.

Intended use

This machine is meant to be used in a professional environment by the personnel listed below:

- **Self-serve users:** Self-serve users are users guided by the screen instructions to operate the machine in a safe mode. Self-serve users must not conduct any maintenance operations.
- **Trained operator staff:** Trained operator staff are staff able to operate the machine and execute the cleaning and maintenance activities described in this manual.

Operation

This machine is only suitable for producing coffee and hot water products. Take note of the following instructions:

- This machine is designed for **Nespresso** Professional capsules, available exclusively through **Nespresso** and its authorised distributors.

- Ensure all necessary maintenance work is done following the instructions and intervals recommended in this user manual.
- If you do not plan to use the machine for a long period of time (weeks), please ensure to empty it, unplug it and disconnect the water mains supply (if the machine is plumbed in). Refer to the chapter “Settings” for more information.
- All operations other than those mentioned in this user manual, must only be performed by authorised and trained service providers of **Nespresso** aftersales centres.

Cleaning the machine

- The machine has to be cleaned daily to ensure hygiene and food safety, preserve your machine lifetime and contribute to an excellent **Nespresso** experience.
- Machine cleaning and maintenance shall not be made by children without supervision.
- This machine needs to be descaled. Always read the safety precautions on the descaling package before proceeding. Avoid contact with eyes, skin and surfaces.
- Refer to the chapter “Daily cleaning and maintenance” for a complete guide to successfully clean your machine.

Avoid contamination during machine handling:

- **Microbiological contamination:** use sanitized fresh material (e.g. paper towels) or clean hands, when conducting machine maintenance. Do not use materials such as cloths or sponges.
- **Chemical contamination:** use adequate chemical agents for the sanitation (e.g. non-odor chemicals, mild detergents).
- **Physical contamination:** do not introduce foreign materials that can fall into the consumer cup.
- **Allergenic contamination:** use specific tools for cleaning the coffee outlet and never use tools that have been in contact with other food products (e.g. milk).
- Do not put in the microwave plastic parts or any components of the machine.
- Do not clean machine components in the dishwasher.
- Do not clean plastic parts with alcohol, ethanol, methanol, methylated spirits, disinfectants. Detergents with strong acid agents such as acetic acid must not be used either.
- Do not clean the machine with high pressure such as water jets.
- Clean coffee outlet only with

single-use disposable tissues or paper towels.

Machine hygiene

- Frequent automated rinsing (internally and externally) takes place to sustain high hygiene standards throughout the machine lifetime.

Maintenance work

- The machine must be serviced by authorised and trained service providers at least every 25,000 beverages per coffee head.
- A notification will appear on the coffee machine display if the machine needs to be serviced.

Disposal

- We recommend that you contact **Nespresso** to dispose of the machine, components and packaging; follow all local regulations.

Limitations of liability

- The manufacturer accepts no liability for any injuries or accidents if the safety instructions covered in this manual are not adhered to.
- The manufacturer cannot be held liable for any damage caused by misuse or inappropriate handling of the machine.

- The manufacturer does not accept any liability for consequences arising from both internal and external modifications of the machine.

Warranty regulations

- The warranty provisions apply as agreed with **Nespresso**.
- Malfunctions due to misuse or connecting unsuitable connections are not covered by warranty.
- Wear and tear parts are not covered by warranty.
- All **Nespresso** machines must pass stringent controls. Reliability tests under practical conditions are performed randomly on selected units. This can show traces of previous use.

Risk of material damage

- This equipment is to be installed to comply with the applicable federal, state or local plumbing codes.
- Wrong handling of the machine can lead to property damage.
- This machine is designed for indoor use. Keep it in such a controlled environment (protected from dust, water splashes, direct sunlight, pests, etc).
- Please make sure that the Pest Control system is in place and that

the machine is located in an area with Pest Control Monitoring.

- Position the machine on a flat, horizontal, stable, heat-resistant and fluid-resistant surface.
- Do not position the machine where a water jet might be used for cleaning.
- Machine should be placed in a space with sufficient ventilation around (see Machine set-up section of this user manual for more information).
- Store the machine in a dust-free and dry environment, always at a temperature above 0 °C.
- The machine and base cabinets have been developed in compliance with the regulation on accessibility by people with a disability. Please check your local regulation for further information.
- Never use the machine without drip grid.
- Do not store explosive or flammable substances such as aerosol cans with a flammable propellant inside the appliance.
- For optimal performance, the ambient temperature must be between 5 °C and 32 °C.

MACHINE OVERVIEW

Overview of the parts

- 1 Capsule insertion slot
- 2 Touch control panel
- 3 Coffee outlet
- 4 Cup support
- 5 Drip tray
- 6 Water tank with lid
- 7 Drip grid
- 8 Main switch
- 9 Cup heater
- 10 Capsule container
- 11 Water filter
- 12 Water hardness test strip
- 13 Key for water tank door

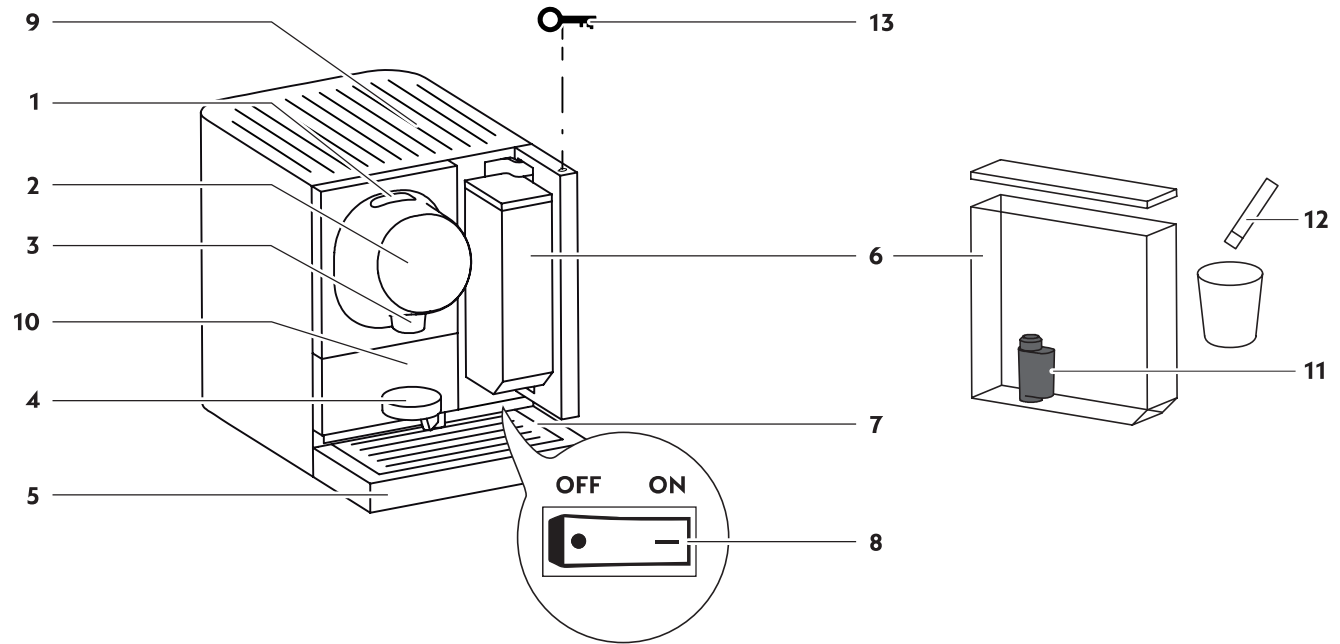

Home screen

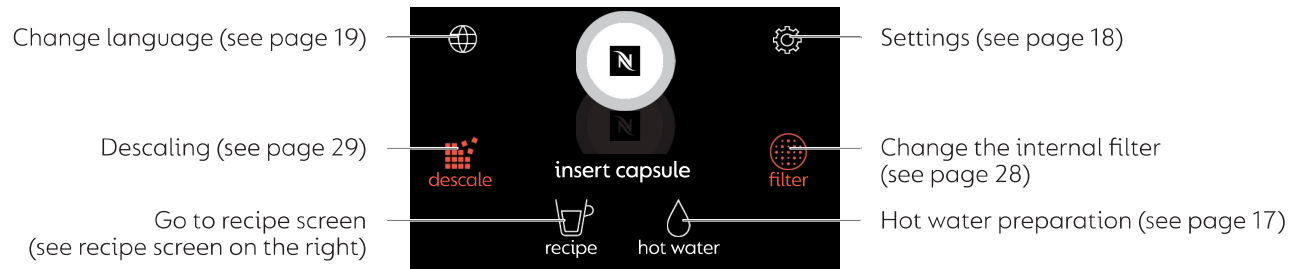

Recipe screen



Recurring screen symbols

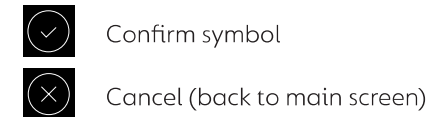
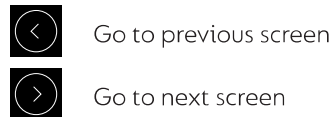

MACHINE SET-UP

Machine installation

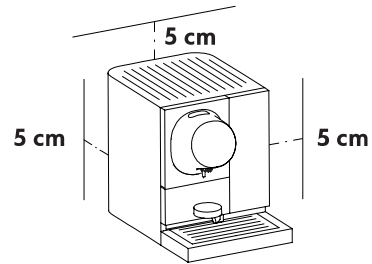

Please ensure the coffee machine is placed in a location with sufficient ventilation (at least 5 cm space on the back, on the sides and top of the machine).

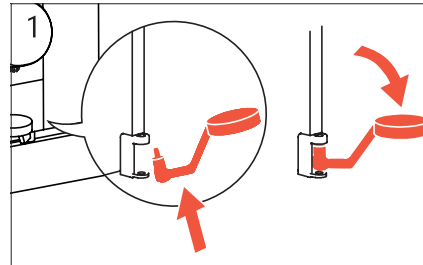

1
Insert cup support by tilting it into position.

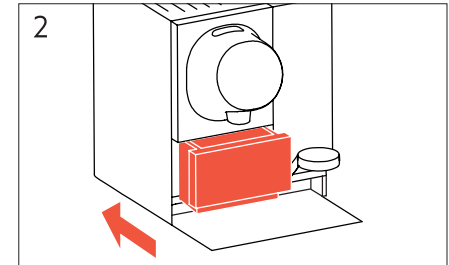

2
Insert capsule container.

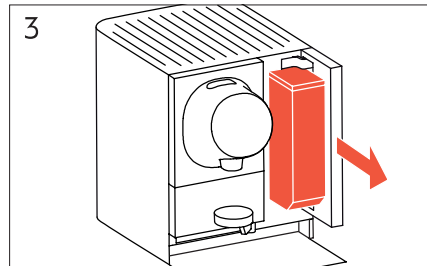

3
Remove water tank from machine.

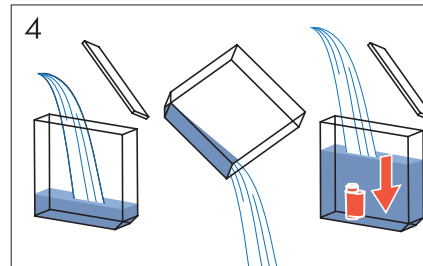

4
Remove water tank lid. Rinse with fresh potable water. Insert water filter into water tank. Fill water tank with fresh drinking water and attach lid again.

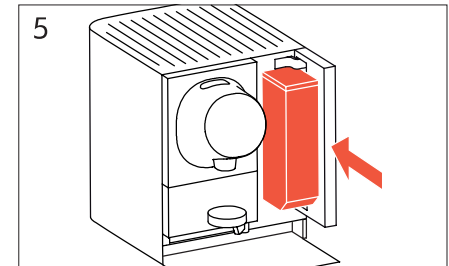

5
Insert water tank back to machine.

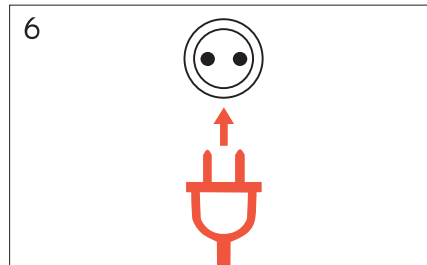

6
Connect power plug to mains power socket. Ensure to use the correct mains voltage as given in "Specifications" on page 34.

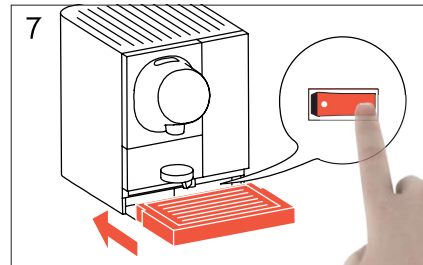

7
Switch on machine. Insert drip tray with drip grid.

Set-up/first use

 Set-up/first use settings will only show up once or after the machine is reset to factory settings.

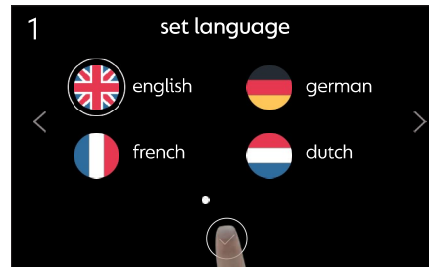

Select desired language and tap on “confirm” symbol.



Use left or right arrows to set time zone and tap on “confirm” symbol to proceed to set time and date.



Select an option and tap on “next” symbol to proceed to set standby time and time to sleep.

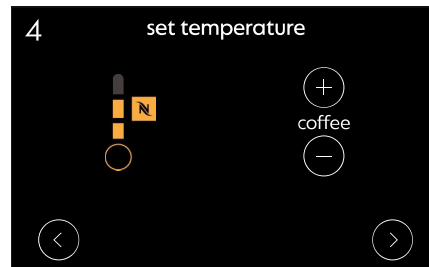

Set coffee temperature. It can be set with +/- . **Nespresso** recommends temperature as displayed.

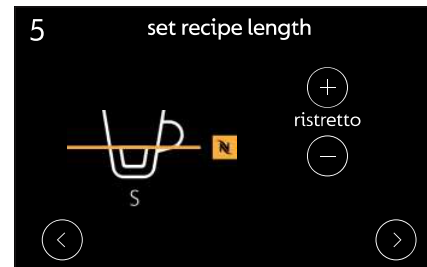

If it is intended to use **Nespresso** branded cups, set recipe length for all cup sizes and recipes. **Nespresso** recommends recipe length as displayed.

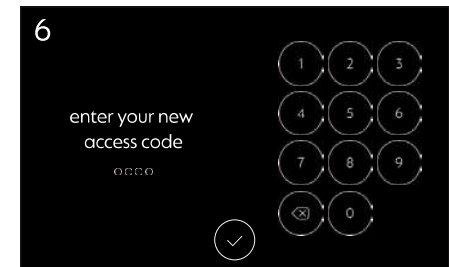

Enter new access code and tap on “confirm” symbol. Proceed with water filter installation and follow instructions.

Cup heater

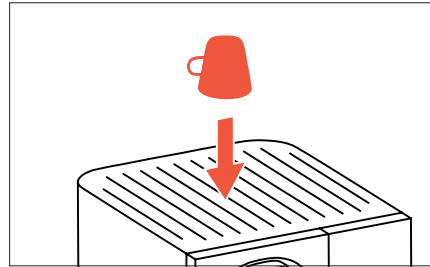

The cup heater is located on top of the machine. If a cup shall be heated, it must be placed upside down.

- i** Only glass/ceramic cups are accepted. Do not place paper/plastic/disposable cups on cup heater. See “Energy saving modes” on page 21 to switch on/switch off cup heater.

PREPARE YOUR BEVERAGE



Coffee preparation

i Everytime the machine is started, it will do a rinsing to ensure the perfect cup of coffee. Every 2 hours the machine will rinse briefly.

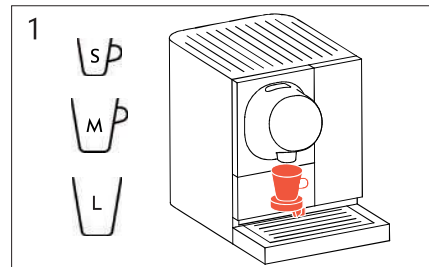

1 Select the right cup (size) for your drink. Use cup support for small and medium cups. Move cup support to the side if a large cup is used.

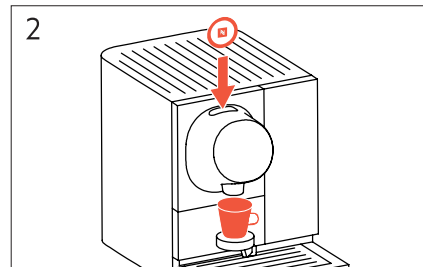

2 Place cup under the coffee outlet. Insert capsule into capsule slot.

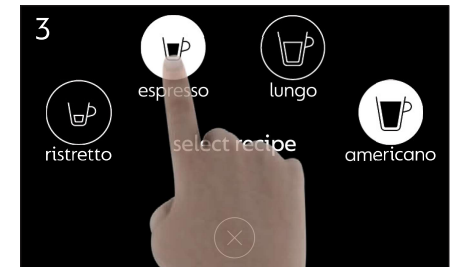

3 Select recipe. Recommended recipes for the inserted capsule are highlighted.

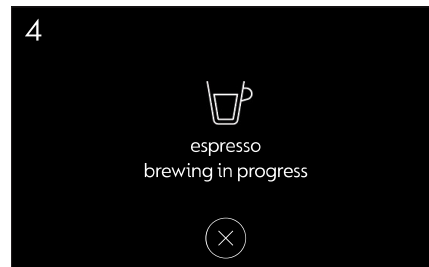

4 The screen displays the preparation whilst the beverage is being prepared. Preparation can be stopped manually by tapping on "cancel" symbol.

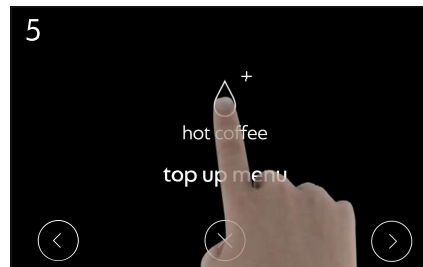

5 After finishing preparation press "hot coffee" symbol to manually start preparation again.

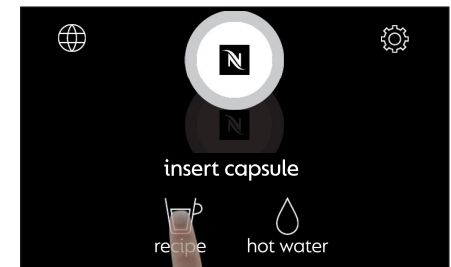

i Press "recipe" symbol on home screen to access recipe screen directly.

Hot water preparation

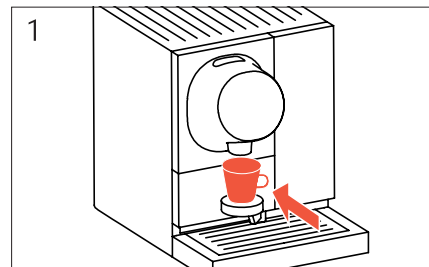

1 Place a cup under the coffee outlet.



2 Press "hot water" symbol to fill the cup with hot water.

SETTINGS



Change language



Tap on “language” symbol to access language menu.



Select desired language and tap on “confirm” symbol.

Settings menu



Tap on “settings” symbol to access settings menu.

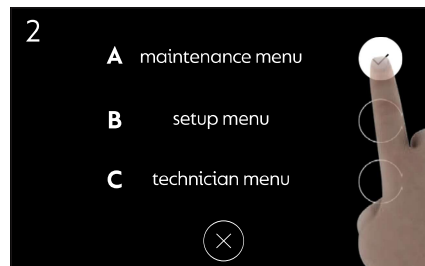

A Maintenance menu: service procedures
B Setup menu: general settings
C Technician menu: can only be accessed by a trained **Nespresso** technician

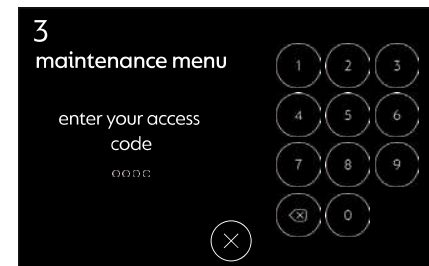

All three menus are protected. The default code for maintenance menu and setup menu is 8888. This code can be customised in the setup menu (see page 22).

Maintenance menu

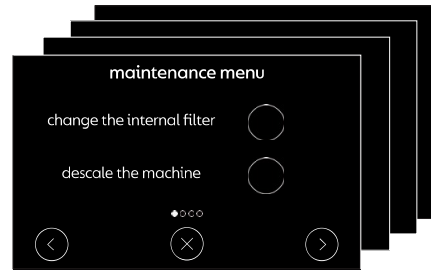

After entering the code, the first maintenance menu appears. Select an option by tapping on circle next to it and follow instructions.

Maintenance menu options:

1. Change the internal filter: See page 28
2. Descale the machine: See page 29
3. Reset the cabinet capsule container counter: Set counter back to 0. Available only on machines equipped with the **Nespresso** base cabinet (optional).
4. Display the connectivity status: Network data are displayed. Available only on machines equipped with telemetry (optional).
5. Display the log: Automatic protocol of software events i. e. to diagnose problems.
6. Display the serial number and software version: Serial numbers and software versions of the corresponding machine parts are displayed.
7. Emptying the machine: Prepare the machine for long storage or transportation.

Emptying the machine

Maintenance menu > emptying the machine

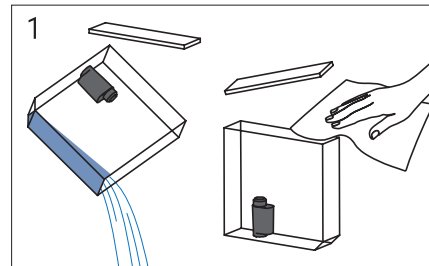

Remove water tank lid. Empty and rinse with fresh potable water. Dry with disposable tissue or paper towel. Attach lid again. Insert water tank back to machine.

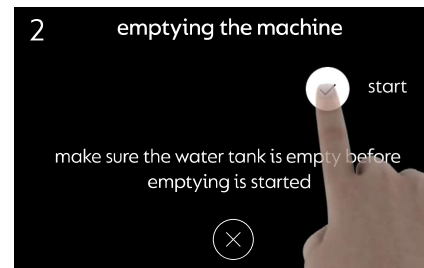

Enter maintenance menu. Select "emptying the machine" menu and press start.

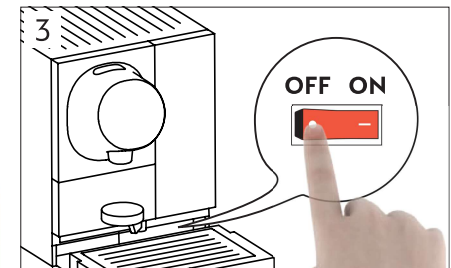

Once machine is successfully emptied, turn it off by pressing the ON/OFF button. Unplug the machine.

Setup menu

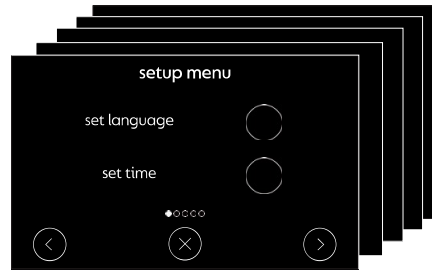

After entering the code, the first setup menu appears. Select an option by tapping on circle next to it and follow instructions.

Setup menu options:

1. Set language: See page 19
2. Set time: Set timezone, time and date
3. Set energy saving modes: See page 21
4. Set temperature: See page 21
5. Set cup size: See page 22
6. Set recipe: See page 22
7. Set access code: See page 22
8. Set water hardness: See page 23
9. Reset to factory settings: See page 23

Set energy saving modes

Setup menu > set energy saving modes

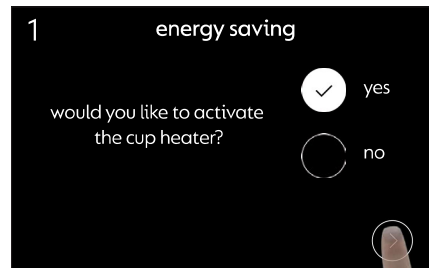

Activate/deactivate cup heater and tap on “next” symbol.

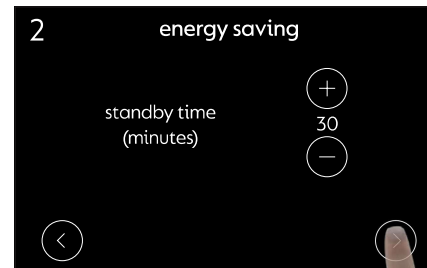

Select time after machine enters standby mode. In this mode, machine automatically turns on again if a user gets near the machine.

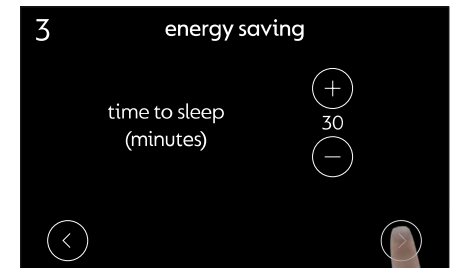

Select time after machine enters sleep mode. In this mode, a control panel has to be touched to turn on the machine again.

Set temperature

Setup menu > set temperature

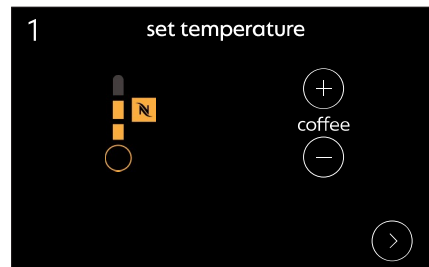

Set coffee temperature with +/- . Tap on “next” symbol to proceed to setup menu. **Nespresso** recommends temperature as displayed.

Set cup size

Setup menu > set cup size



Select “yes” if you use **Nespresso** branded cups. If not, select “no”. The machine will help you to define the size of your cups.

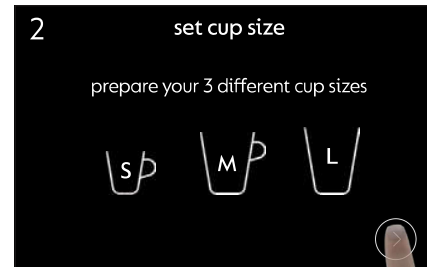

Have your standard small, medium and large cups available. Tap on “next” symbol, follow instructions on the screen and place smallest cup under coffee outlet.



Press start to fill cup and press stop when full. Repeat procedure with medium and large cup. You can skip a cup size by tapping on “next” symbol.

Set recipe

Setup menu > set recipe

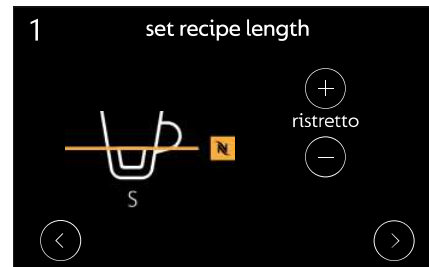

Set recipe length for all available recipes with +/- . **Nespresso** recommends recipe length for each recipe as displayed.

Set access code

Setup menu > set access code

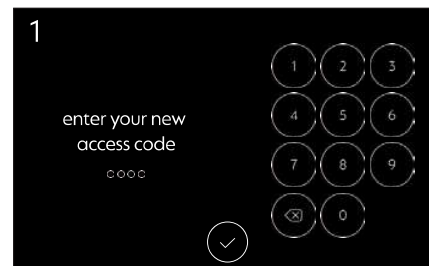

The default access code for the maintenance and setup menu is 8888. Enter new access code and tap on “confirm” symbol.

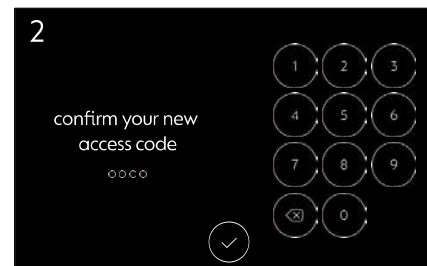

Confirm new access code and tap on “confirm” symbol.

Set water hardness

Setup menu > set water hardness

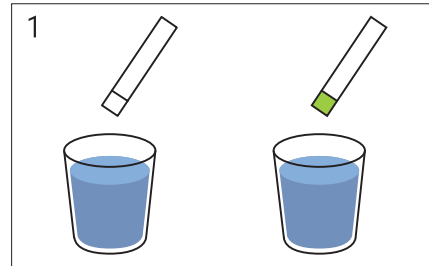

1 Prepare items as instructed. After 1 minute in water, the test strip is coloured.

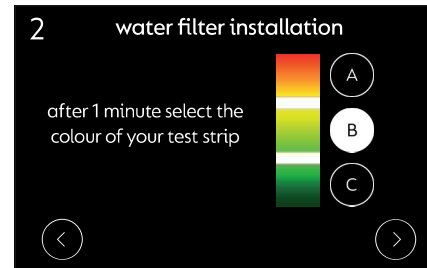

2 Tap on "A", "B" or "C" symbol to match the colour of your test strip. Tap on "next" symbol to proceed.

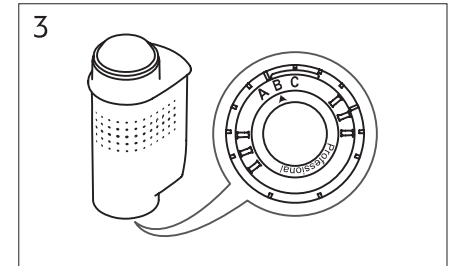

3 Adjust the bottom ring on the water filter to "A", "B" or "C" as recommended.

Reset to factory settings

Setup menu > reset to factory settings

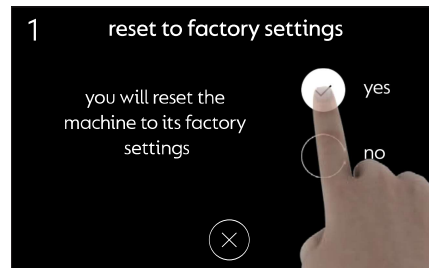

1 Select "yes" to reset the machine to its factory settings. To cancel, select "no" or tap on "cancel" symbol.

i If machine is reset to factory settings, all customised settings will be lost!

DAILY CLEANING AND MAINTENANCE



Introduction

Your **Nespresso** machine has been developed according to the highest standards of quality and reliability. In order to ensure excellent performance and in-cup quality, please conduct the following maintenance operations at the required frequency:

- **Daily machine cleaning (see below)**
- **Water scale maintenance (see page 29)**

Please remember to use mild non-odor detergents and non-abrasive tools.

Rinse water tank (daily)

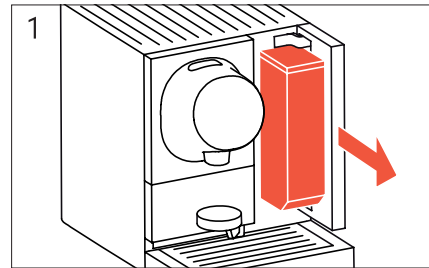

1 Remove water tank from machine.

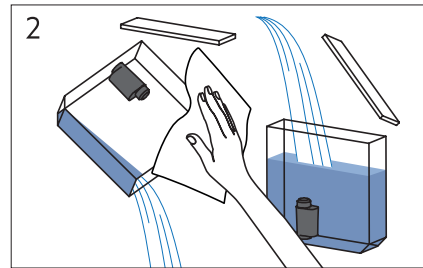

2 Remove water tank lid. Empty, clean with a cloth and rinse with potable water. Fill water tank with potable water and attach lid again.

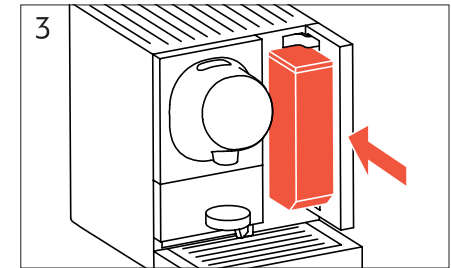

3 Insert water tank back to machine.

Clean capsule container (daily)

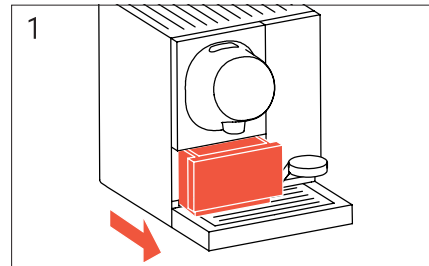

1 Swing cup support to the side and remove capsule container.

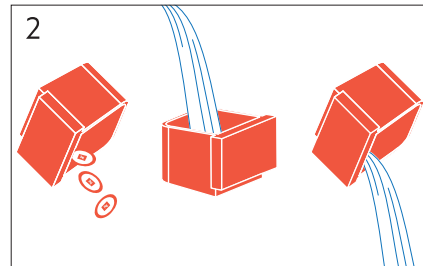

2 Empty capsule container, wash with soapy water and clean it.

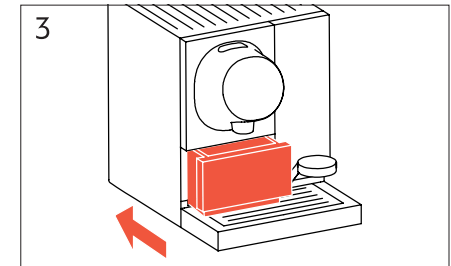

3 Insert capsule container back to machine.

Clean drip tray (daily)

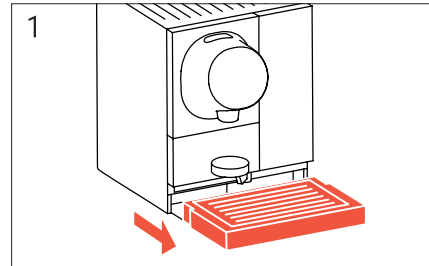

1 Remove drip tray with drip grid.

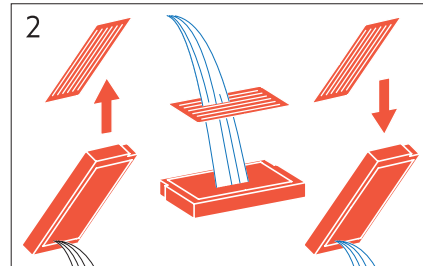

2 Remove drip grid from drip tray. Empty drip tray. Wash with soapy water, rinse and dry both elements.

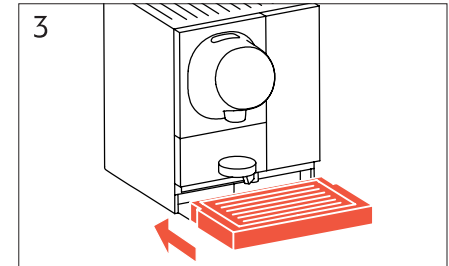

3 Insert drip tray with drip grid back to machine.

Clean coffee outlet (daily)

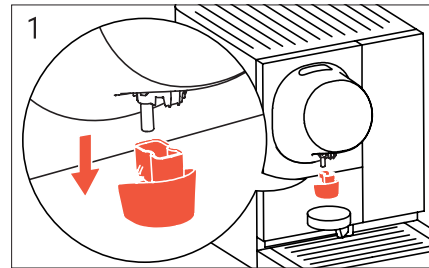

1 Remove coffee outlet cover. Be careful, hot water might drip.

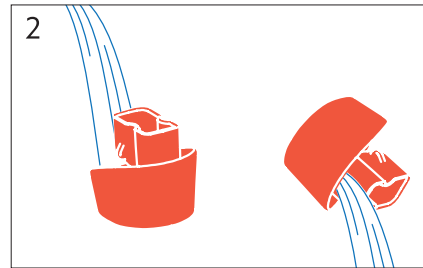

2 Rinse coffee outlet cover with fresh potable water and dry it.

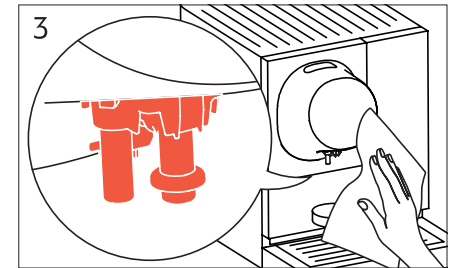

3 Clean coffee outlet with a disposable tissue or paper towel.

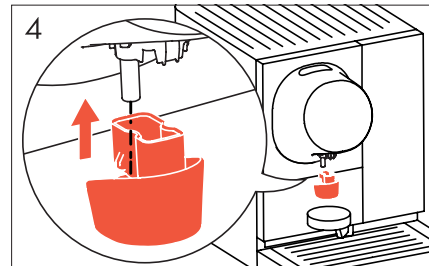

4 Insert coffee outlet cover back into the machine.

Clean cup heater (daily)

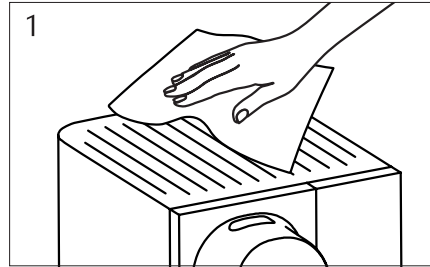

Clean cup heater with a disposable tissue or paper towel. Be careful, it might be hot.

Change the internal filter



When the “filter” symbol appears in red the internal filter should be changed. Tap on red filter symbol and follow instructions on screen.

i Alternatively, settings menu can be entered to start the internal filter procedure.

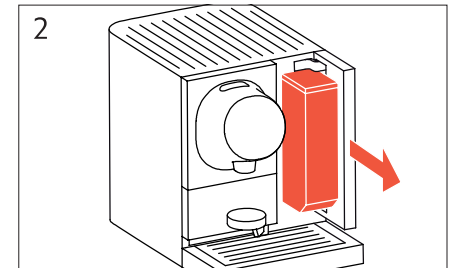

Remove water tank from machine. Clean tank.

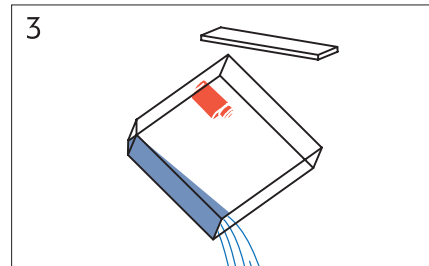

Remove water tank lid. Empty and rinse with fresh potable water.

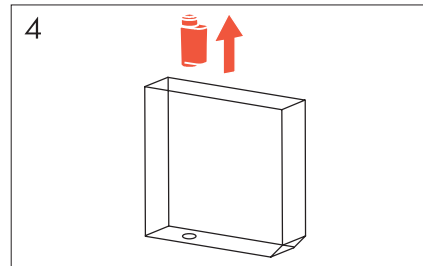

Remove old water filter from water tank.

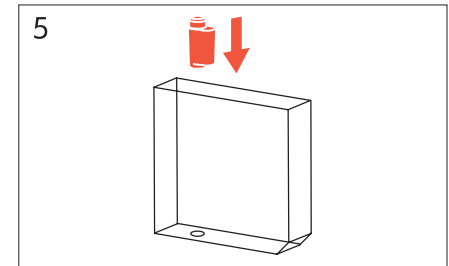

Insert new water filter.

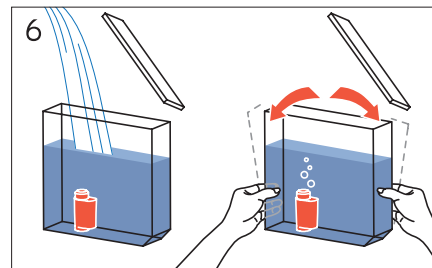

Fill water tank with fresh drinking water and attach lid again. Tilt the water tank back and forth to remove air bubbles from the filter.

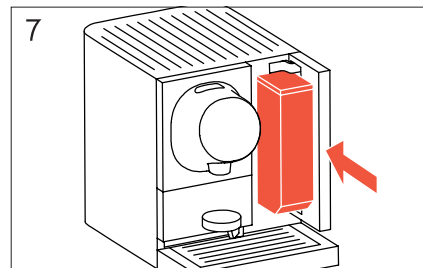

Insert water tank back to machine.

Descaling



i For descaling, use **Nespresso** liquid descaler. **Never** use vinegar.

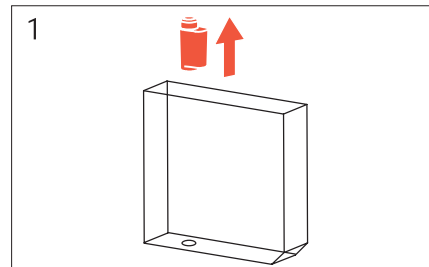

If the machine is equipped with a water filter, always remove it before descaling.

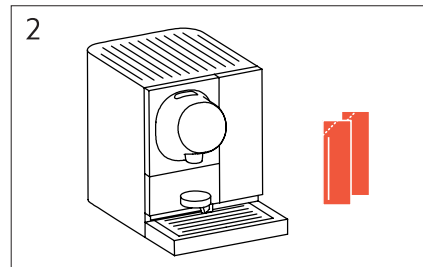

The machine requires 2 bags of **Nespresso** liquid descaler.



When the “descal” symbol appears in red machine should be descaled. Tap on red descaling symbol and follow instructions on screen. Machine will descale for approximately 10 minutes.

i Alternatively, settings menu can be entered to start descaling procedure.

Descaling: interval

Water hardness (see page 23)		For an average consumption of ...		
		25 recipes per day	50 recipes per day	80 recipes per day
		Please descale after:		
	High water hardness (A)	~8 months	~4 months	~2 months
	Medium water hardness (B)	~10 months	~5 months	~3 months
	Low water hardness (C)	~16 months	~8 months	~5 months

TROUBLESHOOTING

No light

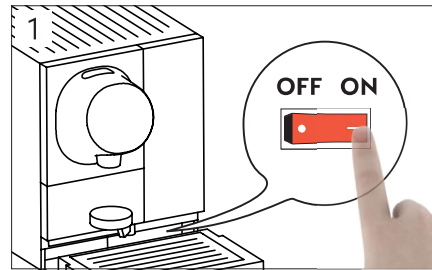

Machine cannot be switched on/no light.

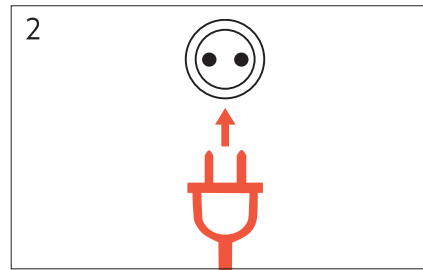

Check if power plug is connected to mains power socket.

Red symbols on main screen

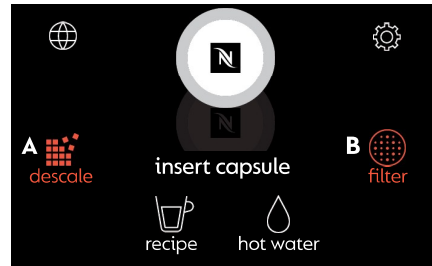

- A** Red “descale” symbol: the machine needs to be descaled (see page 29)
- B** Red “filter” symbol: change the internal filter (see page 28)

Operational alerts

Alert type	Problem	Potential solution
Warning	Warning: error code #, please contact machine operator.	Switch off/on the machine. If warning message persists, contact your machine operator.
Warning	Warning: Momento 100 is cooling down, please wait.	Wait for the machine to cool down. If warning message persists, contact your machine operator.
Warning	Warning: Brewing unit jam: please press (x). If that did not work, contact machine operator.	Press (x) at the bottom of the screen. If that did not work, check if something is stuck on the machine brewing unit. If so, unplug the machine, try to push down the obstructed object with a tool (e.g. spoon, stirrer). If problem persisted, contact machine operator.
Warning	Warning: Direct water connection issue: please contact machine operator.	Switch off/on the machine. If warning message persists, contact your machine operator.
Maintenance warning	Warning: Machine service to be performed. Please contact machine operator.	Please contact your machine operator to arrange machine maintenance.
Maintenance warning	Warning: Please clean the water tank.	Please clean the water tank as described in the User Manual.

Other machine issues

Problem	Potential solution
The language displayed is not appropriate	Modify language settings in your machine setup menu. If problem persists, contact your machine operator.
The machine enters in sleep/standby mode too quickly	Modify energy-saving settings in your machine setup menu. If problem persists, contact your machine operator.
The temperature of Momento 100 beverages is too hot/too cold	Modify temperature settings in your machine setup menu. If problem persists, contact your machine operator.
The length of Momento 100 beverages is too long/too short	Modify cup size / recipe length settings in your machine setup menu. If problem persists, contact your machine operator.
Momento 100 seems to function, yet no water/coffee comes out of the coffee head	Ensure there is water in the machine's water tank. Ensure there is no air stuck in the water filter. To do that, fill the water tank with fresh drinkable water, introduce the filter upside down, and ensure all air inside the filter is out, place your filter on the water tank and try the machine again.
Cup heater does not work	Turn on cup heater. See "Energy saving modes" on page 21 to turn on/turn off cup heater.

APPENDIX

Direct water connection

The machine can be connected to the water network directly. Thus, water filter needs to be changed less often. No water refill is required.

Telemetry

The machine can be connected to internet. This allows bi-directional communication with the machine, which enables the following benefits:

- Visualize machine coffee consumption and health status
- Update machine options
- Receive additional **Nespresso** services

Specifications

A trained Nespresso technician is required (plumber installation) and pressure needs to be set between 2 – 4 bars.

Power supply:

100 – 127 V / 50 – 60 Hz (IEC certification)
120 V / 60 Hz (UL certification)
220 – 240 V / 50 – 60 Hz (IEC certification)

Weight: 16 kg

Operation temperature range: +5 °C – +32 °C

Storage temperature range: –25 °C – +60 °C
(please empty your machine before storage)

Water tank capacity: 3 L

Dimensions (W x D x H): 300 x 500 x 420 mm

Noise emission: < 55 dBA

Type plate

The type plate contains the following details:

Machine type: Nespresso Professional Coffee Machine

Model: Momento 100

Type: 230/NP100

Voltage: according to type plate

Power: according to type plate

Serial number: according to type plate

Production date: according to type plate

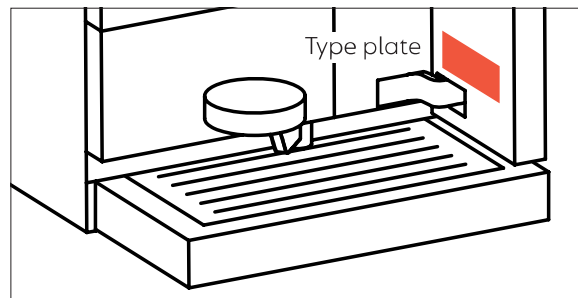

Recycling capsules and machine at end of life

This appliance complies with the EU Directive 2012/19/EC. Packaging materials and appliance contain recyclable materials.

Your appliance contains valuable materials that can be recovered or can be recycled.

Separation of the remaining waste materials into different types facilitates the recycling of valuable raw materials.

Leave the appliance at a collection point.

You can obtain information on disposal from your local authorities.

To know more about **Nespresso** sustainability strategy, go to www.nespresso.com/positive

Publishing details

Version: User manual Momento 100
Original user manual

Contact Nespresso

For service calls, contact your country-specific **Nespresso** representative on www.nespresso.com



Nestlé Nespresso SA
Avenue de Rhodanie 40B
1007 Lausanne
Switzerland



www.nespresso.com/pro