



AGUILA²²⁰

User manual EN

Bedienungsanleitung DE

Manuel de l'utilisateur FR

Manuale d'istruzioni IT





	Ristretto Intenso	Ristretto Origin India	Ristretto	Espresso Forte	Espresso Leggero	Espresso Origin Brazil	Lungo Origin Guatemala	Lungo Forte	Lungo Leggero	Espresso Decaffeinato	Lungo Decaffeinato					
Ristretto																
Espresso																
Lungo																
Espresso Macchiato																
Cappuccino																
Latte Macchiato																
Iced Macchiato																
Cortado Lungo																
Cortado																
Flat white																
Cappuccino Lungo																
Cappuccino Chiaro																
Cappuccino Freddo																
Iced Cappuccino																
Latte Grande																
Latte																
Latte Piccolo																
Iced Latte																
Macchiatissimo																

EC-Declaration 4

Machine Overview 5

Packaging Contents 5

Operating Overview 5

General Information 6

Safety Warnings 7

General Safety Instructions 8

First Use 9

Energy Saving Mode 10

Maximum Energy Saving Mode 10

Coffee Preparation 11

Milk-Based Coffee Recipes 12

Milk Preparation 13

Hot Water Preparation 13

Daily Cleaning 14

Menu Settings 16

- Language setting 16

- Statistics 16

- Navigation 16

- Milk parameters 16

- Cup heater 16

- AGUILA+ button programming 17

Alarms / Notifications 17

Specifications 19

Type Plate 19

Impressum 19

EC-Declaration

EU DECLARATION OF CONFORMITY

We
Thermoplan AG, Thermoplan-Platz 1,
 CH-6353 Weggis, Switzerland

declare under our sole responsibility that the product

Product	Automatic Coffee Machine
Model	AGUILA
Type	AG220PRO

to which this declaration relates, is in conformity with the following standards.

CISPR 14-1(ed.5);am1;am2	61000-3-2(ed.4)
CISPR 14-2(ed.1;am1;am2	61000-3-3(ed.3)
60335-1(ed.5)	61000-6-2(ed.2)
60335-2-15(ed.5);am1;am2	61000-6-3(ed.2);am1
60335-2-75(ed.2);am1;am2	62233(ed.1)
60335-2-89(ed.2);am1	

following the provisions of directives:

2011/65/EU (RoHS)
2004/108/EC (EMC)
2006/42/EC (MD)
1935/2004/EC (FCM)
2023/2006/EC (GMP)

This product also complies with essential safety requirements of the Low Voltage Directive:

2006/95/EC (LVD)

CH-6353 Weggis,
 13.03.2015
 Adrian Steiner, CEO

Responsible for the technical documentation is:
 Christian Huber



Machine Overview

See machine overview in: ► page 2.

Packaging Contents

The following components are included in the delivery:

- Machine
- Milk container with cover
- User manual
- Thermoplan cleaning tablets
- Extraction tool for coffee outlets
- Water filter & head
- Water tube to connect main water inlet



The machine can communicate with a Cash Management System.

Please contact your Nespresso representative for further information.



Always fill milk container with cold milk (below 5 °C).

- 1 Capsule insertion slots
- 2 Cup heater
- 3 Lever
- 4 Energy saving mode button (behind capsule container)
- 5 Hot water outlet
- 6 Coffee outlet
- 7 Used capsules container (capacity 130 capsules)
- 8 Drip grid / Drip tray
- 9 Drip grid for small cups
- 10 Main switch (underneath)
- 11 Coffee outlet
- 12 Milk outlet
- 13 Milk suction tube and sensors (milk level and temperature)
- 14 Milk container (max. 5 l)
- 15 Milk container cover
- 16 Waterfilter with head and water tubes
- 17 Extraction tool for coffee outlet
- 18 Thermoplan cleaning tablets
- 19 Cleaning key
- 20 System cleaning
- 21 System rinsing
- 22 Hot water
- 23 Coffee preparation buttons
- 24 Coffee / hot water outlets
- 25 Coffee / milk outlets
- 26 Coffee preparation buttons
- 27 Milk-based coffee recipes buttons
- 28 Milk & milk foam buttons
- 29 Display

Operating Overview



Beverage selection:
To view the name of the product on the display, press product button for 5 sec. To exit, wait 10 sec. without pressing any button.



Hot water

Coffee preparation buttons:



Ristretto



Espresso



Lungo

Milk and milk foam buttons:



Hot milk foam



Hot milk



Cold milk foam

Milk-based coffee recipes buttons:



AGUILA +
(refer to user menu settings)



Espresso Macchiato



Cappuccino



Latte Macchiato



Iced Macchiato

Coffee preparation buttons:



Ristretto



Espresso



Lungo

Cup Description for NESPRESSO Grand Cru Recommendation

See Nespresso Grand Cru recommendation in: ► page 3.



Espresso cup



Lungo cup



Cappuccino cup



300 ml recipe glass



350...400 ml recipe glass



500 ml take away cup

General Information

Important!

Read these instructions carefully before use and keep it in a safe place for further reference.

Improper use of the machine releases *Nespresso* from any liability.

Summary

This user manual describes the operating instructions for the AGUILA 220 espresso coffee machine and is delivered with the machine.

Personnel Requirements

Only the listed personnel - if trained - is authorized to use the AGUILA 220 espresso coffee machine.

Service provider

- If you have any questions or problems, contact *Nespresso* representative.

Trained technician

- Trained technicians are employees trained and certified, who sell and maintain products.

Trained operator staff

- Trained operator staff are employees who were briefed and trained in the use of the coffee machine (reading of the user manual) and who are able to operate the machine and execute the maintenance steps described in this manual.

Operation

This machine is only suitable for producing coffee, milk and hot water products and is suitable for commercial use in the catering trade. Therefore, please take note of the following instructions:

- This machine works with *Nespresso* capsules, available exclusively through *Nespresso* and its authorized distributors.
- The milk container must only be used to store cold milk. Do not fill the milk container with any liquids other than milk (e.g. syrup or alcohol). Please note that when pouring the milk into the milk container it must have a temperature of below 5 °C, as the refrigerator has been designed to keep the milk cool but not to lower its temperature.
- Carry out all necessary maintenance work as described in these instructions at regular intervals.
- The machine must only be operated by trained operator staff.
- All operations other than those mentioned in this manual must only be performed by authorized and trained service providers of *Nespresso* aftersales centers.
- The capsules container must be emptied when the corresponding notification appears on the display. Rinse the container with a solution of warm, soapy water.

Cleaning the machine

Cleaning the machine on a daily basis is an absolute must, as it guarantees necessary hygiene and food safety, perfect *Nespresso* grand cru taste as well as a longer life of the machine. Please refer to chapter "Daily cleaning" for a complete guide to successfully clean your machine. Also take note of the following instructions:

- Use only the Thermoplan milk cleaning tablets to perform the automatic cleaning process. Do not use any other cleaning detergent or disinfection agent for this purpose.
- When touching the coffee machine, in particular the spouts, bacterial contamination must be avoided.
- Cloths or sponges must be wrung out thoroughly to ensure that they are only moist, not wet, otherwise there is a risk of electric shock.
- Plastic parts must not be dried in the microwave.
- Do not clean plastic parts with alcohol, ethanol, methanol, methylated spirits or disinfectants. Detergents with strong acid agents such as acetic acid must also not be used.
- The machine must not be cleaned with water jets.
- The milk suction tube with temperature sensor and level sensor, as well as all internal parts of the refrigerator, cleaning key, coffee outlets shall be cleaned only with single-use tissue or paper towel. Clothes used to clean external parts of the machine shall be properly treated to prevent possible bacterial contamination.

Machine hygiene

- Frequent automated rinsing (internally and externally) takes place to sustain high hygiene standards throughout the machine life time.

Commercial use

- This machine is intended to be used by experts or trained users in shops, light industry and on farms.

Maintenance work

- A notification will appear on the coffee machine display if the machine needs to be serviced. The machine must be serviced by authorized and trained service providers at least once every year or every 24'000 product beverages.

Disposal

- An authorized and trained service provider has to dispose of the machine and its packaging. Do not dispose of the machine or its components yourself.

Limitations of liability

- The manufacturer accepts no liability for any injuries or accidents if the safety instructions covered in this manual are not adhered to.
- The manufacturer cannot be held liable for any damage caused by misuse or inappropriate handling of the machine.

Warranty regulations

- The warranty provisions apply as agreed with *Nespresso*.
- Malfunctions due to misuse or connecting unsuitable connections shall not be compensated.
- Wear and tear parts are not covered by any warranty.
- All *Nespresso* machines must pass stringent controls. Reliability tests under practical conditions are performed randomly on selected units. This can show traces of any previous use.

General Notes:

Risk of material damage

- This equipment is to be installed to comply with the applicable federal, state or local plumbing codes.
- Wrong handling of the machine could lead to property damage.
- The machine is for indoor use only.
- Clean machine before taking out of service for a longer period of time. Remove and empty capsules container, disconnect machine from the mains. Remove and empty milk container, clean and store with lid open. Leave refrigerator door open.
- Ambient temperature must be between 16 °C and 32 °C.
- Position machine on a flat, horizontal, stable and heat-resistant surface.
- Do not position machine where a water jet could be used to clean.
- Leave a gap of at least 50 mm in front of air vents.
- Store machine in dust free and dry environment, always at a temperature above 0 °C.
- The top of the machine must be at least 1.5 m above the floor.
- Place machine 20 cm or further away from the user.
- Use Thermoplan cleaning accessories only.
- Never use the machine without drip grid.
- The manufacturer does not accept any liability for consequences arising from both internal and external modifications on the machine.
- Do not store explosive substances such as aerosol cans with a flammable propellant inside the appliance.
- Never use the cup heater for drying wet cups; risk of electric shock.
- Always place cups upside-down to ensure good heat transmission.

Safety Warnings

Structure

The safety instructions in this document are structured as following:

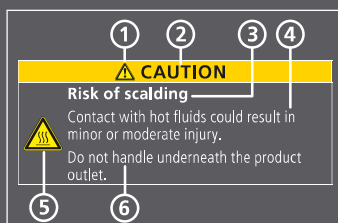

- | | |
|----------------------|-------------------------|
| 1 Safety sign | 4 Impact |
| 2 Safety signal word | 5 Specified safety sign |
| 3 Source | 6 Prevention |

Safety signal words

The following warning messages are used in the present manual:

WARNING	indicates a hazardous situation which, if not avoided, could result in death or serious injury.
CAUTION	indicates a hazardous situation which, if not avoided, could result in minor or moderate injury.
NOTICE	addresses practices that could lead to property damage but not to injury.

i	Hint addresses practices that help the reader to use the equipment properly.
----------	--

Safety signs

The following safety signs are used in this manual:

	The warning triangle appears where nonadherence to the safety instructions may result in risks to the user or the machine.
	Warning: Electric shock
	Warning: Risk of scalding
	Warning: Risk of bruising
	Instruction: Wear gloves
	Instruction: Wear goggles
	General information

Working Area

- Keep your workspace clean and tidy. Disorder and unlit workspaces can lead to accidents.
- The machine must only be operated in a hygienic and ergonomic environment. The user must have sufficient space and the working area must be well lit.

General Safety Notes

- In the event of emergency, switch off the machine using the main switch. Unplug the machine or remove the fuse from the fuse box. Contact your service provider.
- This appliance can be used by children aged from 8 years and above and persons with reduced physical, sensory or mental capabilities or lack of experience and knowledge if they have been given supervision or instruction concerning use of the appliance in a safe way and understand the hazards involved. Children shall not play with the appliance. Children are not permitted to clean and perform maintenance on the machine without supervision.
- The access to the service area is allowed to trained service personnel and instructed personnel only.

General Safety Messages

WARNING:

Risk of electric shock

Contact with electrical components during operation of the machine could result in death or serious injury.

- Do not open casing under any circumstances.
- Keep the machine away from moisture.
- Never immerse the machine, cable or plug in water or any other liquid.
- Immediately stop using the machine if cable or plug are damaged.
- Do not position the machine or cable near or on hot parts of the machine. Using the machine near open flames is strictly prohibited.
- Protect the cable from sharp edges.
- Do not reach up inside the inner casing when the capsules container is removed.
- Have the machine installed, relocated, removed, repaired or maintained by authorized, trained service staff.
- The machine and its supply cables must be positioned out of the reach of children.

CAUTION:

Risk of scalding

Contact with hot fluids could result in minor or moderate injury.

- Do not handle underneath the product outlet.
- Avoid direct contact with hot fluids.
- Do not touch any dispenser before or after a beverage is being dispensed.
- Do not open the lever while a product is being dispensed or the machine is being cleaned.
- Empty the drip tray with caution.

Risk of bruising

Handling inside the machine could result in minor or moderate injury.

- Do not open lever during preparation. To stop preparation, press the same product button again.
- Do not put fingers into the capsule insertion slots.
- If a capsule is blocked in the capsule insertion slot, switch off machine before any operation.

Risk of food intoxication

Ingestion of contaminated food could result in death or serious injury.

- Only use food with a sell-by date that has not yet expired.
- Store food in suitable locations.
- Clean the machine periodically and in accordance with the user manual.
- Only use heat treated (e.g. pasteurised or ultra heat treated) milk.
- Observe hygiene standards while pouring milk into the container.
- Only pour milk that has already been cooled down (below 5 °C) into the milk container.
- Use opened milk containers within 24 hours.

First Use

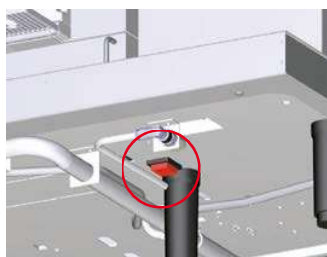

CAUTION

Risk of bruising

Handling inside the machine could result in minor or moderate injury.

Do not put fingers into the capsule insertion slots.



Switch-on facility main water supply.

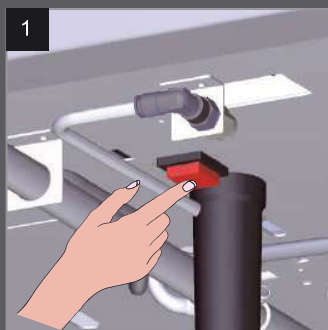

1

The main switch is located underneath the machine.

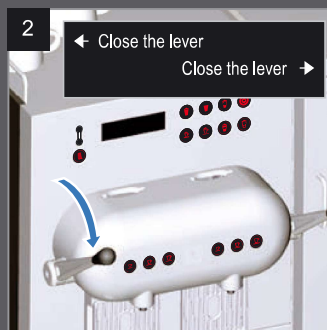

2

Close both levers.

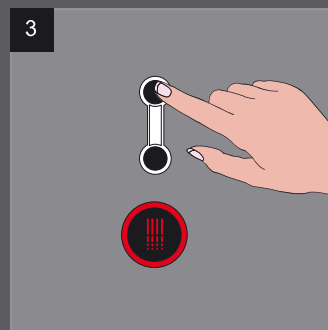

3

Press any button.



4

Machine performs a cold start rinse (display shows a time counter).



5

Machine heats up. All buttons flash in white.

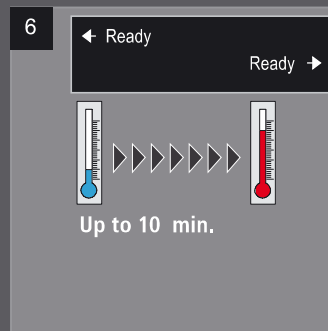

6

If the machine has heated up, all buttons will be permanently lit in white.



During rinsing the noise level increases.

CAUTION

Risk of food intoxication

Ingestion of contaminated food could result in minor or moderate injury.

Only use heat treated (e.g. pasteurised or ultra heat treated) milk.

Observe hygiene standards while pouring milk into the container.

Use opened milk container within 24 hours.



CAUTION

Risk of food intoxication

Usage of non-disposable tissue or sponge can lead to bacterial contamination of the milk.

Use only single-use disposable tissue or paper towel to wipe milk suction tube with temperature sensor and level sensor.



To clean the outside of the machine, refer to external cleaning ► see page 14.



7

Open both levers.

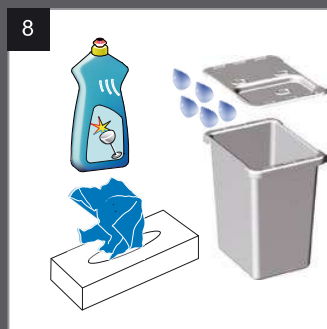

8

Thoroughly clean the milk container and cover with a commercially available foodsafe household cleaner.



9

Carefully wipe milk suction tube with temperature sensor and level sensor, using only single-use disposable tissue or paper towel.

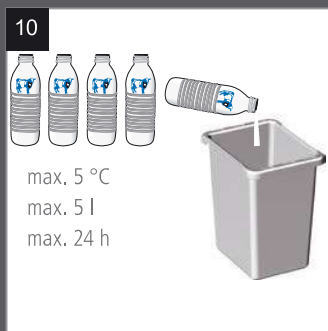

10

max. 5 °C
max. 5 l
max. 24 h



Change the milk every 24 hours.



11

Insert milk suction tube with temperature sensor and level sensor through cover into the milk container.

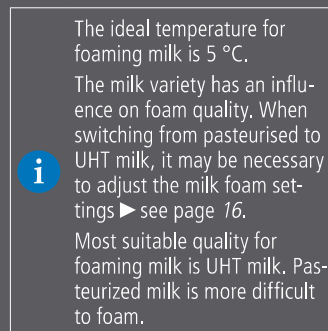

The ideal temperature for foaming milk is 5 °C.

The milk variety has an influence on foam quality. When switching from pasteurised to UHT milk, it may be necessary to adjust the milk foam settings ► see page 16.

Most suitable quality for foaming milk is UHT milk. Pasteurized milk is more difficult to foam.

Energy Saving Mode



The machine switches to energy saving mode after 30 min. of non-use. All buttons appear white, boiler heating is reduced, fridge is still working. Press any button to return the machine to operating mode.

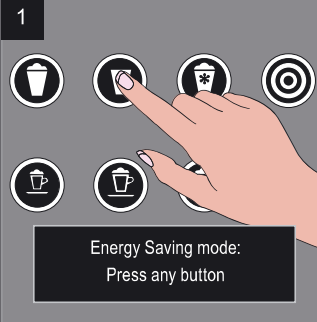

Maximum Energy Saving Mode



"Maximum energy saving mode" can be activated by pressing the button for 3 sec.

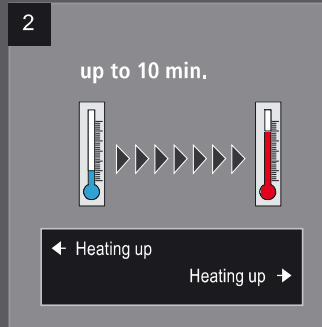
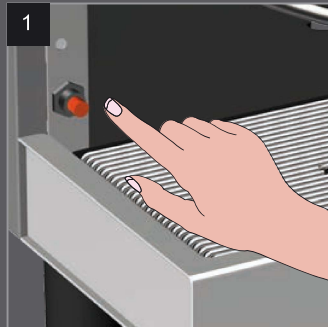

After four hours of non-use, the machine switches to maximum energy saving mode. Boiler heating is switched off, fridge is still working. Press energy saving button to restart the machine.



Machine starts an automatic rinse or may require a cold start rinse. ▶ See First Use on page 9. If required close both levers.

Coffee Preparation



Ristretto



Espresso



Lungo

i Coffee heads can be used simultaneously to prepare coffee.

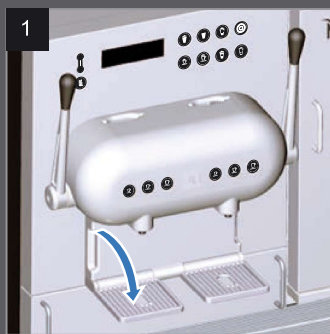

1 Pull down drip grid for small cups.

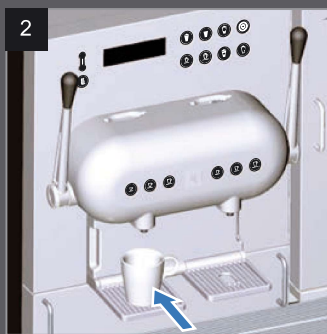

2 Insert a coffee capsule.

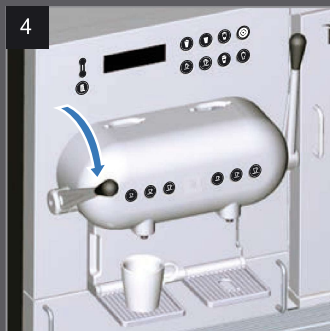
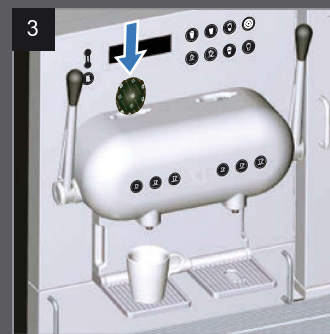

4 Pull down lever to the lowest position.

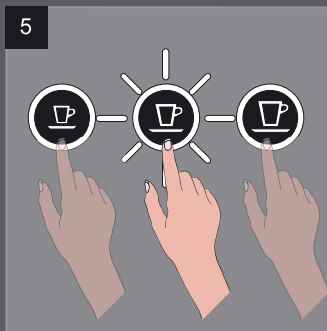

5 Choose cup size desired (example Espresso).

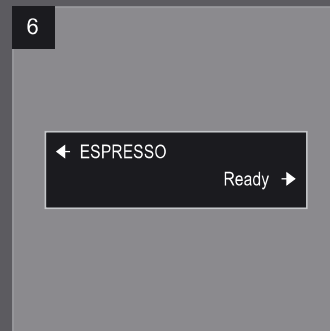

6 Product name is displayed during preparation.

i ▶ See *Nespresso Grand Cru* recommendation on page 3.

Top up / stop products

All product preparations can be stopped by pressing the product button again.

i To top up your drink with some more beverage, press the product button within 1 min. after the end of product preparation. Press product button again to stop.

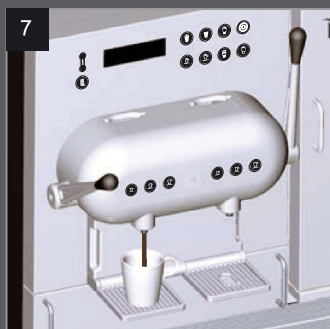

7 Coffee preparation starts.



8 Top up or stop product dispensing within 1 min.



9 By pulling up the lever, the used capsule is ejected.



10 Machine is ready for next beverage.

Milk-Based Coffee Recipes

-  Espresso Macchiato
-  Cappuccino
-  Latte Macchiato
-  Iced Macchiato
-  AGUILA+

i For milk-based coffee recipes, place your cup under the right hand-side outlet.

i Do not remove your cup until display shows "Ready" again. Some products have a brief pause between milk and coffee dispensing. Sequence of dispensing may vary depending on the product.



Insert a coffee capsule.



Pull down lever to the lowest position.

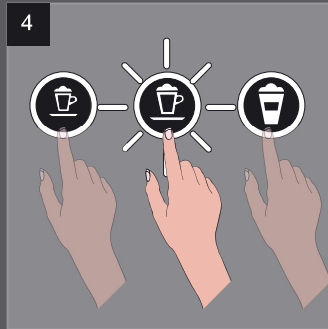

Choose desired milk-based coffee recipe (example Cappuccino).

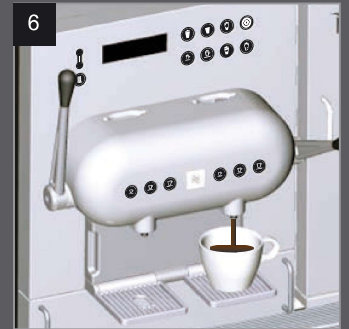

Coffee preparation starts.



Foaming milk preparation according to chosen product.



By pulling up the lever, the used capsule is ejected.



Milk system rinsing

The milk system is rinsed automatically in order to ensure high hygiene standards.

CAUTION

Risk of scalding

The milk system will be rinsed automatically 5 min. after the preparation of a milk-based beverage.



Duration approx. 10 sec.

Avoid direct contact with hot water.

Protect hands from scalding.



Automatic internal rinsing: An approx. 3 sec. internal rinsing of the milk system will begin immediately after each milk-based beverage preparation.



Automatic external rinsing: An approx. 10 sec. automatic rinsing of the milk system will begin 5 min. after the last milk-based beverage preparation.

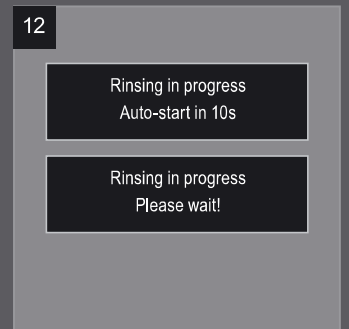

Rinsing in progress
Auto-start in 10s

Rinsing in progress
Please wait!

Milk Preparation

-  Hot milk foam
-  Hot milk
-  Cold milk foam

i For milk preparations, place your cup under the right hand-side outlet.

Milk system rinsing

The milk system is rinsed automatically in order to ensure high hygiene standards.

CAUTION
Risk of scalding
 The milk system will be rinsed automatically 5 min. after the preparation of a milk-based beverage.
 Duration approx. 10 sec.
 Avoid direct contact with hot water.
 Protect hands from scalding.

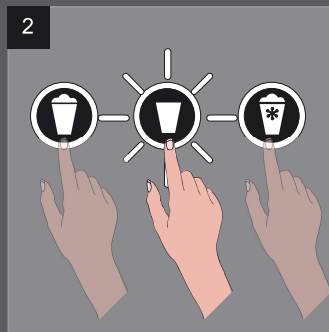

Choose desired milk product (example Hot Milk).

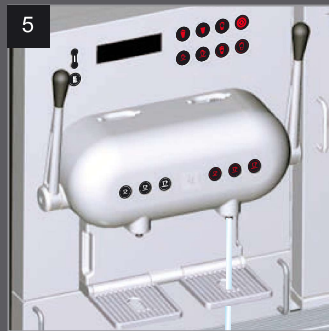

6

Rinsing in progress
Auto-start in 10s

Rinsing in progress
Please wait

Automatic internal rinsing: An approx. 3 sec. internal rinsing of the milk system will begin immediately after each milk-based beverage preparation.
 Automatic external rinsing: An approx. 10 sec. automatic rinsing of the milk system will begin 5 min. after the last milk-based beverage preparation.

Hot Water Preparation

-  Hot water

i For hot water preparations, place your cup under the left hand-side outlet.

CAUTION
Risk of scalding
 Contact with hot fluids could result in minor or moderate injury.
 Avoid direct contact with hot water.
 Protect hands from scalding.

i Top up or stop product dispensing within 1 min.

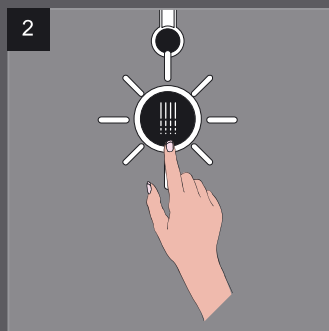

3

← HOT WATER Ready →



6

← Ready Ready →

Daily Cleaning

(duration app. 30 minutes)



The display will show a reminder with a timer 2 hours before mandatory daily cleaning is required.

The machine daily cleaning is mandatory for maintaining high hygiene standards, ensuring neutral in-cup taste throughout time and for prolonging the machine life-time.

External cleaning

Remember to regularly inspect and, if necessary, clean the exterior of the machine.

Use a damp cloth or sponge soaked in a soap solution. Cloths and sponges must be wrung out thoroughly to ensure they are only moist, not wet, otherwise there is a risk of electric shock.

Only use mild detergents and non-scratch cloths.

Pay particular attention to the product dispensing parts. The display and keyboard must be cleaned with particular care.

Internal cleaning

Follow these instructions carefully to run the automatic cleaning process.



Cleaning tablet insertion

CAUTION

Risk of corrosive injury



Direct contact with cleaning detergent with eyes may cause injury.



Clean your hands after handling cleaning tablets.



Wear gloves/goggles.

NOTICE

Cleaning solutions

The use of inappropriate cleaning solutions may damage parts of the machine or may lead to improper cleaning efficiency.

Use only Thermoplan milk cleaning tablets to perform the automatic cleaning.

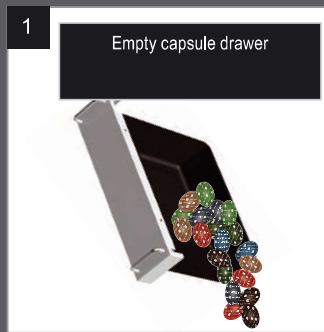

Empty capsule container daily or on display request (Capacity approx. 130 capsules per container).

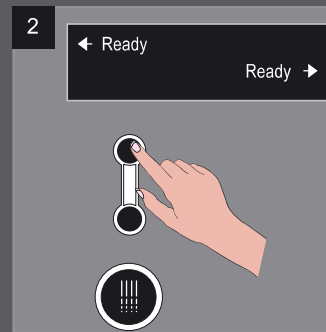

Press cleaning button.



Press the button again and hold for 3 seconds to start the cleaning. Press any other button to exit cleaning.



Carefully remove and drain the milk container.

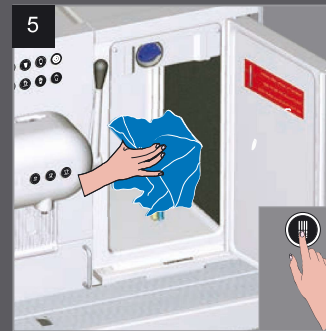

Carefully wipe milk suction tube with temperature sensor and level sensor, using only single-use disposable tissue or paper towel. Afterwards press any button.

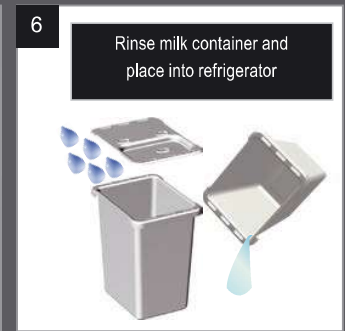

Rinse milk container with potable water.



Place empty container back into the refrigerator and guide the suction tube with temperature sensor and level sensor into the container. Press any button.



Remove cleaning key and insert two cleaning tablets.



Cleaning procedure starts automatically after the cleaning key is inserted.

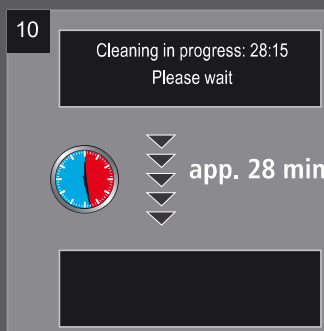

After cleaning process the machine switches to maximum energy saving mode.



To restart machine from maximum energy saving mode, see page 10.



After cleaning, carefully wipe milk suction tube with temperature sensor and level sensor, using only single-use disposable tissue or paper towel. Usage of non-disposable tissue or sponge can lead to bacterial contamination of the milk.



Empty remaining water, clean milk container with potable water and place it back into the refrigerator.

⚠ CAUTION

Risk of scalding



After the cleaning procedure, remaining hot water may drop from product outlets.

Avoid direct contact with hot water.

Protect hands from scalding.

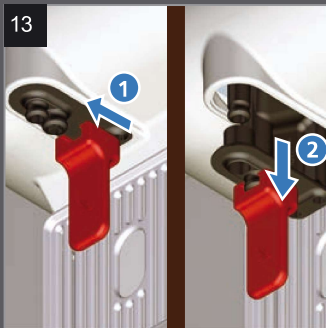

Use extraction tool to pull down coffee outlets.

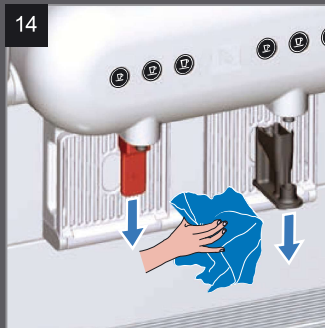

Remove both coffee outlets. Properly rinse coffee outlets with fresh potable water.

Clean milk outlets with damp single-use tissue or paper towel.

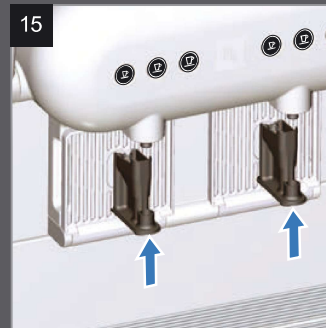

Reinsert coffee outlets.

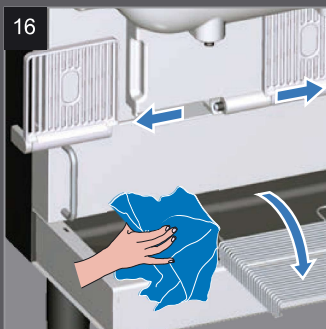

Pull out drip grids for small cups (only in vertical position) and drip tray grill. Clean all parts.

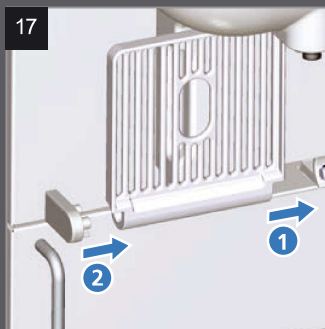

Reinsert the drip grids for small cups.



Daily cleaning procedure completed (machine in maximum energy saving mode). If you need to reactivate the machine, press the energy saving button as per ► page 10.



Drip grids for small cups can only be removed when in vertical position.



Remove the drip grid and wash it with a soft cloth and mild detergent under running water.



Remove the black plastic 'plug' found in the plastic tray.



Pull the metal frame towards you to remove.



Remove and clean the black plastic tray with a soap water solution. Cleaning is complete.



Follow the above steps in reverse order to assemble the drip tray.

Menu Settings

- Language setting

- Statistics

- User product counter
- Products total
- Capsule counter
- User counter reset

i - Navigation

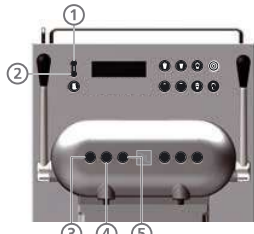

- ① Up next menu / increase value
- ② Down previous menu / decrease value
- ③ Default load default value
- ④ Enter edit / confirm
- ⑤ Escape exit menu / cancel

Language setting

Press rinse button for 3 sec.

USER MENU
GENERAL SETTINGS

Select menu "GENERAL SETTINGS"

Enter

GENERAL SETTINGS
Language = English

Select menu "Language"

Enter

Language = English
◀ English ▶

Select desired language

Enter

Exit menu

Statistics: User product counter

Press rinse button for 3 sec.

USER MENU
STATISTICS

Select menu "STATISTICS"

Enter

STATISTICS
User product counter

Select "User product counter"

Enter

User product counter
◀ Select a product ▶

Select "yes" or "no"

Enter

Exit menu

Check "Products total" or
or "Capsule counter user" (read
only parameters).

Statistics: User counter reset

Press rinse button for 3 sec.

USER MENU
STATISTICS

Select menu "STATISTICS"

Enter

STATISTICS
User counter reset

Select "User counter reset"

Enter

User counter reset
◀ no ▶

Select "yes" or "no"

Enter

Exit menu

Menu Settings

- Milk parameters

- Milk foam settings:
 - Hot foam
 - Cold foam
- Refrigerator settings

- Cup heater

Milk foam settings

To change the fluidity of the milk foam, simply change the % of air in the milk foam as shown on this page:

- -10%: more liquid foam
- 0%: installation setting
- +10%: more solid foam

Milk parameter: Milk foam settings

Press rinse button for 3 sec.

USER MENU
MILK PARAMETERS

Select menu "MILK PARAMETERS"

Enter

MILK PARAMETERS
HOT FOAM = 0 %

Select "HOT FOAM = 0 %"

Enter

HOT FOAM = 0 %
[-10.0 .. ◀ 0 ▶ .. 10.0]

Increase or decrease the amount of air in the hot milk foam if required. Range: -10 % to 10 % from default.

Enter

MILK PARAMETERS
HOT FOAM = 3 %

Repeat this procedure for COLD FOAM if necessary.

Exit menu

Milk parameter: Refrigerator settings

Press rinse button for 3 sec.

USER MENU
MILK PARAMETERS

Select menu "MILK PARAMETERS"

Enter

MILK PARAMETERS
Cooling temperature = 5.0 °C

Select "Cooling temperature = 5.0 °C"

Enter

Cooling temperature = 5.0 °C
[4.0 .. ◀ 5.0 ▶ .. 8.0]

Increase or decrease the cooling temperature if required or set to DEFAULT (recommended).

Enter

Exit menu

Cup heater

Press rinse button for 3 sec.

USER MENU
MACHINE PARAMETERS

Select menu "MACHINE PARAMETERS"

Enter

MACHINE PARAMETERS
Cup heater = On

Select "Cup heater = On"

Enter

Cup heater = on
◀ On ▶

Select "On" or "Off"

Enter

Exit menu

Menu Settings

- AGUILA+ button programming

AGUILA+ button programming

The AGUILA+ button offers the choice of 13 one-touch milk-based coffee recipes. To select the one-touch recipe you would like to be dispensed if the AGUILA+ button is pressed, follow the instructions below. You can change your selection at any time by repeating the same steps.



Press rinse button for 3 sec.

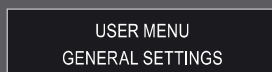

Enter

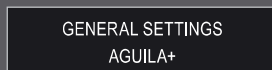

Enter



Select the desired product.



Enter



Exit menu

AGUILA+ recipes

CORTADO LUNGO
CORTADO
FLAT WHITE
CAPPUCCINO LUNGO
CAPPUCCINO CHIARO
CAPPUCCINO FREDDO
ICED CAPPUCCINO
LATTE GRANDE
LATTE
LATTE PICCOLO
ICED LATTE
MACCHIATISSIMO
COLD MILK

See *Nespresso Grand Cru* recommendation on page 3.

Alarms / Notifications

What to do if a "Call technician" message appears? Please call your *Nespresso* representative.

Description	Display message	LED status	Remarks
Change water filter	<p>Alternating</p>		Immediately call your <i>Nespresso</i> representative.
Service required	<p>Alternating</p>		Immediately call your <i>Nespresso</i> representative.
Milk container empty	<p>Alternating</p>		Milk products are locked. Fill up milk container (in fridge).
Milk level low	<p>Alternating</p>		Indicates that the milk container will soon be empty. Fill up milk container (in fridge).
Automatic rinsing mode (5 min. delay)			Automatic rinsing of internal milk system starts 5 min. after last milk-based beverage preparation. "Rinsing in progress" and "Please wait" appear on display. LEDs start to flash 10 sec. before rinsing.
Cleaning required in x.yy h.	<p>Alternating</p>		When timer ends, machine will be locked until cleaned.
Milk system cleaning required	<p>Alternating</p>		Milk products not available. Start cleaning procedure as described on ► page 14.

Alarms / Notifications

Description	Display message	LED status	Remarks
Cleaning of milk system	Press 'cleaning' button for 3s to start cleaning		Start cleaning procedure as described on ► page 14. To quit menu, press any product button.
Milk system cleaning mode	Cleaning in progress 28:15. Please wait		Display shows remaining cleaning time.
Milk temperature high (6...12 °C)	← Ready Milk temperature too high Alternating		Normal operation. Milk products are still available but quality might be downgraded. Replace milk with cold milk at 5 °C.
Replace milk with cold milk (over 12 °C)	← Ready Replace milk with cold milk Alternating		Milk products are locked. Replace milk with cold milk at 5 °C.
Open lever	← Open the lever Ready →		Lift up the lever so that the used capsule is ejected.
Preparation time too long	← Ready Preparation too long →		Open lever and try to insert new capsule. Ensure facility main water supply is switched on. If message appears repeatedly, call your Nespresso representative.
Preparation time too short	← Ready Preparation too short →		Open lever and try to insert new capsule. Message appears if no capsule is inserted. If message appears repeatedly, call your Nespresso representative.
Heating up boiler	← Heating up Ready → Alternating		Slow flashing during heating. If message remains for more than 30 min., call your Nespresso representative.
Energy saving mode	Energy Saving mode: Press any button		Boiler temperature reduced. Machine will be ready within 1 min. after pressing any product button.
Maximum energy saving mode			To reactivate machine press "Energy saving" button. For more info ► see page 10.
Brewing unit end of life	← Brewing unit end of life! Ready →		Immediately call your Nespresso representative.
CCI not connected	CCI NOT CONNECTED		All products blocked. Rinsing and cleaning still possible. Check that the CCI connection is properly installed. If the alarm remains on, call your Nespresso representative.

Specifications

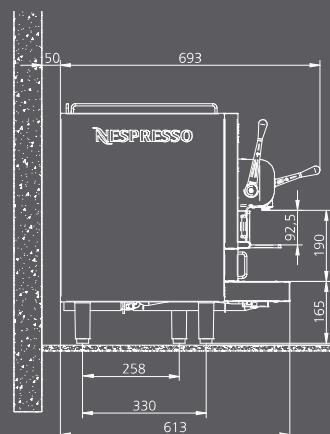
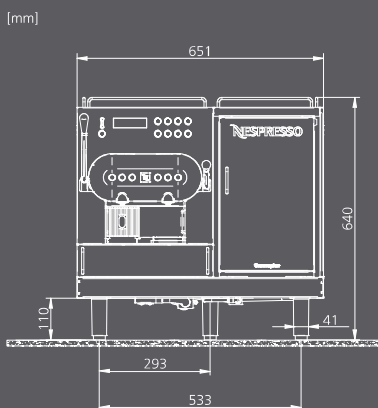

Power supply:	220-240 VAC / 50/60 Hz / 3200-3800 W
	380-415 VAC / 50/60 Hz / 4000-4800 W
	200 VAC / 50/60 Hz / 2700 W
	208 VAC / 60 Hz / 3200 W
	220 VAC / 60 Hz / 3200 W

Dimensions: 651 x 693 x 640 mm (L / W / H)

Weight: 75 kg (empty)
90 kg (in operation)

Outlet height standard: 190 mm

Outlet height drip grid: 92.5 mm

Water supply: G 3/8" male

Water supply pressure: 2...4 bar / 30...60 psi

Noise emission: <60 dBA

Indicative maximum product capacity per machine per hour

	EU	US	JP
Ristrettos:	240	240	220
Espressos:	200	200	180
Lungos:	140	120	110
Cappuccinos:	50	45	42
Hot water:	70	70	70

Water supply minimum requirements

Chlorine:	none
TDS:	70 to 200 ppm
Total hardness:	5-8 °dH (8-14 °fH) pH 6.8 to 7.4
Alkalinity:	less than 100 ppm
Iron:	less than 0.25 ppm

Type Plate

The type plate contains the following details:

Machine type:	NESPRESSO PROFESSIONAL Coffee Machine
Model:	AGUILA
Type:	AG220PRO
Voltage:	according to type plate
Power:	according to type plate
Water Pressure:	0,2-0,4 MPa (2-4 bar)
Hydr. Boiler:	1,46 MPa (14,6 bar)
Class:	5
Refrigerant:	134 a
Charge:	55 g
Low Side Pressure:	88 psig
High Side Pressure:	285 psig
Serial Number:	according to type plate
Production Date:	according to type plate

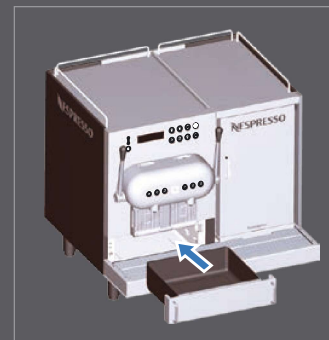

i The capsule container must be removed to see the type plate.
The type plate is located beneath the capsule container on the baseplate.

Impressum

Version:	User Manual AGUILA 220 Original user manual
Manufacturer:	Thermoplan AG Thermoplan-Platz 1 CH-6353 Weggis

Service calls:	For service calls, please contact your country specific <i>Nespresso</i> representative on www.nespresso.com
-----------------------	---